

Smartgen®

HAT220A ATS CONTROLLER

USERS MANUAL



Smartgen Technology



众智电子 Chinese trademark

Smartgen[®] English trademark

Smartgen — make your generator *smart*

Smartgen Technology Co., Ltd.

No. 28 Jinsuo Road

Zhengzhou

Henan Province

P. R. China

Tel: +86-371-67988888/67981888

+86-371-67991553/67992951

+86-371-67981000(overseas)

Fax: 0086-371-67992952

Web: <http://www.smartgen.com.cn>

<http://www.smartgen.cn>

Email: sales@smartgen.cn

All rights reserved. No part of this publication may be reproduced in any material form (including photocopying or storing in any medium by electronic means or other) without the written permission of the copyright holder.

Smartgen Technology reserves the right to change the contents of this document without prior notice.

Software Version

Version	Date	Note
1.0	2013-01-10	Original release

CONTENT

1	OVERVIEW	4
2	PERFORMANCE AND CHARACTERISTICS.....	4
3	SPECIFICATION	5
4	PANEL OPERATION INSTRUCTION.....	6
5	PANEL OPERATION	6
5.1	Delay Adjustment	6
5.2	Restore Factory Default	7
6	PROGRAMMED PARAMETER AND RANGE	7
7	OPERATION CONTROL	8
8	TERMINALS DESCRIPTION	9
9	TYPICAL APPLICATION	10
10	OVERALL DIMENSIONS	11
11	FAULT FINDING.....	11

SmartGen

1 OVERVIEW

HAT220A ATS controller using microprocessor as its core can precisely monitor 2-way 3 phase voltage, single phase voltage; make accurate judgment on abnormal voltage (loss of power, over voltage, under voltage) and control ATS to transfer after delay. When #1 power supply is abnormal, the controller will send signal to start genset.

2 PERFORMANCE AND CHARACTERISTICS

HAT220A ATS controller can monitor 2-way 3 phase voltage, 2-way 2 phase voltage and single phase voltage (can be 2 way mains, 2 way generator, or 1 way mains and 1 way generator) and control ATS to transfer. Its performance and characteristics are as follows,

- Realized computer programming control; can use computer to set voltage abnormal delay, genset stop delay, switch priority, correct voltage value and other functions with overall graphical interface operation. When programming with computer, the front panel must be opened, then use SG72 interface module (USB to LINK) to program via the PC test software. Please refer to “HAT220A Test Software Manual” for more information about PC software.
- The voltage normal delay of #I or #II can be set within (0~60) seconds and the Genset start delay can be set within (0~90) seconds.
- The voltage abnormal delay of #I or #II can be set within (0~60) seconds and the Genset stop delay can be set within (0~90) seconds.
- “#I priority”, “Auto/Manual”, “No priority” and “#II priority” can be set via controller front panel.
- Isolated design of 2-way Neutral.
- ATS running status can be shown clearly with the help of LED which mounted on front panel.
- The output contactor capacity of #I and #II power supply transfer relay (CLOSE 1#, CLOSE 2#) is 16A AC250V/16A DC28V, passive contact, can be directly used in driving switch to transfer.
- The output contactor capacity of Genset start relay (GENS START) is 7A 250VAC/7A 28VDC, passive N/C(normally close) contact.
- Controller has strong ability of anti-electromagnetic interference, can be used under complex electromagnetic interference environment.
- Modular design, anti-flaming ABS plastic shell, pluggable terminals, compact structure and easy installation.

3 SPECIFICATION

a) Rated Voltage and Rated Frequency:

3 Phase 4 Wire, AC380V, 50 Hz /60Hz;

Single phase 2 wire, AC230V, 50 Hz /60Hz;

Over voltage threshold value: 264 V (phase-N)

Under voltage threshold value, 172 V (phase-N)

AC voltage measurement accuracy: 2%

AC phase voltage measurement range: (160~300) V \pm 20%

b) Action time

- ◆ Close time: 5 seconds. During this period, if detected close signal is active, immediately disconnect.
- ◆ Voltage normal delay: (0~60) seconds (can be adjusted via panel potentiometer).
- ◆ Voltage abnormal delay: (0~60) seconds (can be adjusted via panel potentiometer), default: 5 seconds
- ◆ Genset start delay: after 1# abnormal delay (range: 0s~60s, can be adjusted via panel potentiometer), genset start relay closes.
- ◆ Genset stop delay: after 1# normal delay (range: 0s~90s, can be adjusted via panel potentiometer or PC, default: 90 seconds), genset start relay de-energizes.

c) Power consumption

When module is in rated voltage, power consumption of voltage circuit is not more than 2VA.

d) Environment conditions

Working temperature: (-30~+70) °C Humidity: (20~95) %

e) Weight

Net weight: 0.47Kg

4 PANEL OPERATION INSTRUCTION

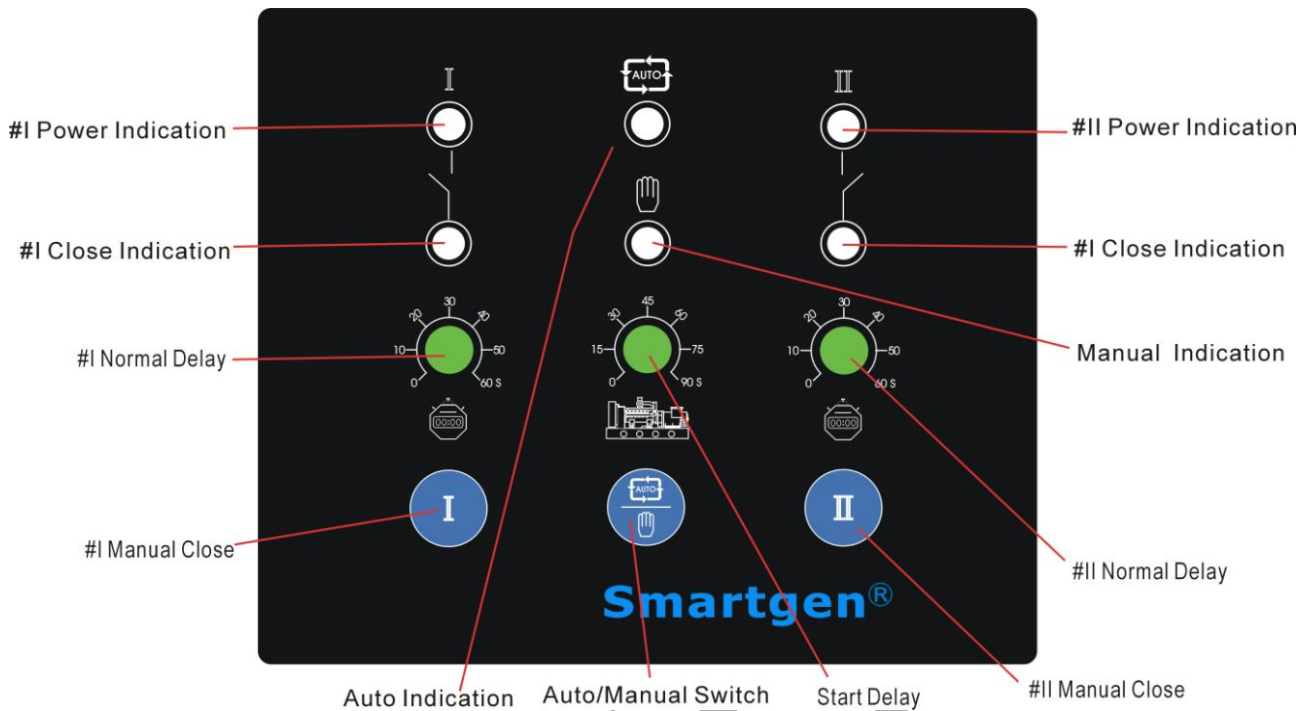

5 PANEL OPERATION

5.1 Delay Adjustment





- ◆ Adjusting “#I normal delay” potentiometer can set output delay after #I power supply normal.
- ◆ Adjusting “#II normal delay” potentiometer can set output delay after #II power supply normal.
- ◆ Adjusting “start delay” potentiometer can set genset start signal output delay after #I power supply abnormal.

Setting Procedures of “#I abnormal delay”, “#II abnormal delay” and “Genset stop delay”

- a) Press **I** and **II** at the same time, #I/#II power indicator and automatic indicator are flashing simultaneously; furthermore, when **I** and **II** are released, three indicators eliminate simultaneously, which means the delay timer of the controller can be set.
 - #I abnormal delay: adjust “#I Normal Delay” potentiometer;
 - #II abnormal delay: adjust “#II Normal Delay” potentiometer;
 - Genset stop delay: adjust “Start Delay” potentiometer;

- b) After adjusting the delays, press ; when #I/#II power indicator and automatic indicator are flashing simultaneously, which means the adjusted value has been saved. Controller will work according to the delays.

5.2 Restore Factory Default

- a) Press  and  at the same time, #I/#II power indicator and automatic indicator are flashing simultaneously; furthermore, when  and  are released, the three indicators eliminate simultaneously, which means the delay timer of the controller can be set.
- b) Press ; when #I/#II power indicator and automatic indicator are flashing simultaneously, the factory default has been restored. Controller will work according to the set delays.



Note: By default, #I and #II abnormal delay are 5s and genset stop delay is 90s.

6 PROGRAMMED PARAMETER AND RANGE









No	Items	Range	Default	Notes
1	#I Normal Delay	(0~60)s	Can be set via controller panel potentiometer	It can only be set via controller panel potentiometer.
2	#II Normal Delay	(0~60)s		
3	Genset Start Delay	(0~90)s		
4	Genset Stop Delay	(0~90)s	90s	It can be set via controller panel potentiometer or PC setting.
5	#I Abnormal Delay	(0~60)s	5s	
6	#II Abnormal Delay	(0~60)s	5s	
7	Over Voltage	(50~300)V	264V	It can only be set via PC
8	Under Voltage	(50~300)V	172V	
9	Priority Select	1# priority, 2# priority, No priority	1# priority	It can be set via controller panel potentiometer or PC.
10	AC System	3P4W; 1P2W	3P4W	

7 OPERATION CONTROL

Auto/Manual operation,

When controller is running, pressing  can set the controller as Auto mode or Manual mode (via automatic and manual indicators). In Manual mode, press  key, load will be transferred to #I power supply; press  key, load will be transferred to #II power supply.







Procedures of setting “#I priority”, “#II priority” and “No priority”

- 1) Press ,  and  at the same time, #I/#II power indicator and automatic indicator are flashing simultaneously; furthermore, when ,  and  are released, the three indicators eliminate simultaneously, which means controller priority can be set.
- 2) Pressing  can circularly set 3 priority conditions of power supply.
 - **#I Priority:** #I power indicator illuminates and #II power indicator eliminates;
 - **#II Priority:** #II power indicator illuminates and #I power indicator eliminates;
 - **No Priority:** #I power and #II power indicators are illuminating simultaneously;
- 3) After adjusting, press , #I power indicator, automatic indicator and #II power indicator are illuminating simultaneously, which means the adjusted power priority has been saved. And controller will work according to the set.



Note: Once the controller is powered on, its priority can be judged by the following three conditions.

- If #I power supply indicator flashes rapidly for three times, indicating #I power supply for priority transfer.
- If #II power supply indicator flashes rapidly for three times, indicating #II power supply for priority transfer.
- If #I and #II power supply indicators flash simultaneously for three times, indicating there is no priority transfer.

Procedures of setting 3P4W, 1P2W:

- 1) Press ,  and  at the same time, #I/#II power indicator and automatic indicator are flashing simultaneously; furthermore, when ,  and  are released, the three indicators eliminate simultaneously.
- 2) Press , #I/#II power indicator and automatic indicator are flashing simultaneously;

furthermore, when  is released, the three indicators eliminate simultaneously, which means controller AC system can be set.

- 3) Pressing  can circularly set 2 AC systems.
 1. **1P2W**: #I close indicator illuminates;
 2. **3P4W**: #I #II close indicators and automatic indicator illuminates simultaneously;
- 4) After adjusting, press , #I power indicator, automatic indicator and #II power indicator are illuminating simultaneously, which means the adjusted AC system has been saved. And controller will work according to the set.

Note: Once the controller is powered on, its AC system can be judged by the following two conditions.

- If #I close indicator illuminates, indicating 1P2W AC system.
- If #I #II close indicators and automatic indicator illuminates simultaneously, indicating 3P4W AC system.

8 TERMINALS DESCRIPTION



- ◆ Terminals A1, B1, C1 and N1: Separately connect to A, B, C and N of #1 power. (For 1P2W, A1 and N1 are separately connected to A and N of #I power supply).
- ◆ Terminals A2, B2, C2 and N2: Separately connect to A, B, C and N of #II AC power. (For 1P2W, A2 and N2 are separately connected to A and N of #II power supply).
- ◆ Terminal L1: #I closing status input (active when connect AC220V).
- ◆ Terminal L2: #II closing status input (active when connect AC220V).
- ◆ Terminals M1 and M2: Passive contact of closing #I relay (contact capacity is 16A AC250V/16A DC28V).
- ◆ Terminals M3 and M4: Passive contact of closing #II relay (contact capacity is 16A AC250V/16A DC28V).
- ◆ Terminals M5 and M6: Passive normally closed contact of genset start relay (contact capacity is 7A AC250V/7A DC28V).

9 TYPICAL APPLICATION

3P4W Typical Wiring Diagram

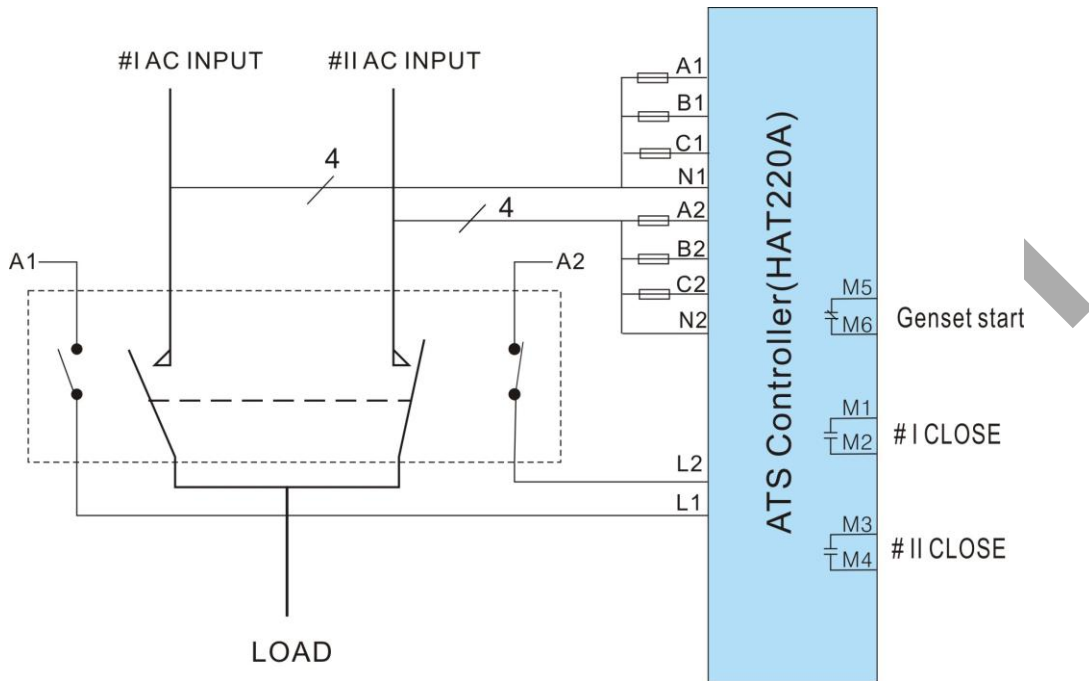

1P2W Typical Wiring Diagram

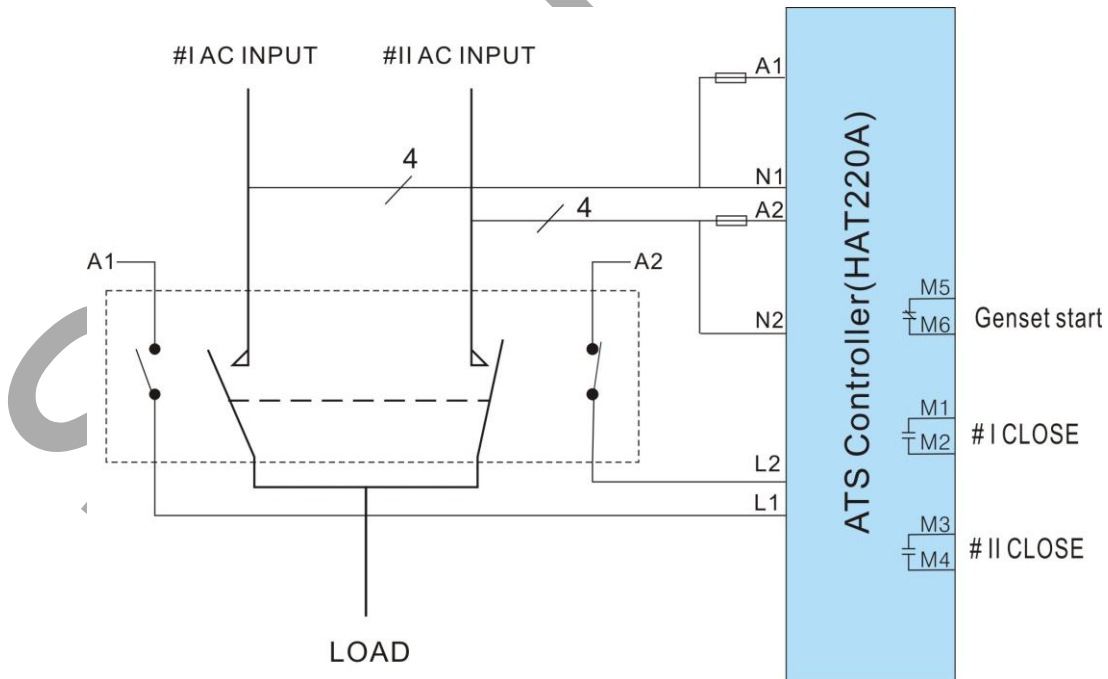

10 OVERALL DIMENSIONS

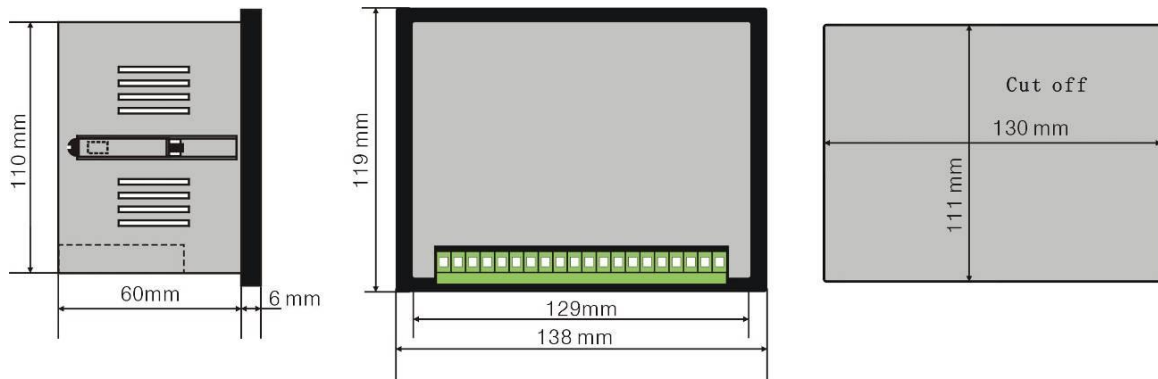

11 FAULT FINDING

Symptom	Possible Remedy
Controller is inoperative	Check connections of controller.
Switch is not activated	Check ATS; Check the connections between controller and ATS.
Parameter detection error	Check connection wirings of controller and amend detecting values of electric parameters.
Communication error with PC	Check setting of communication port and its wirings.